

PowerTower™ Pro Certification Module

PowerTower Pro 180/200/225/250



Table of Contents

PowerTower™ Pro Specifications

Specifications for the PowerTower Pro 180/200/225/250	Page 2
MLB Diagram	Page 5

CUDA Reset

For Your Safety	Page 3
Purpose of CUDA Reset.....	Page 4

Bezel Removal/Installation

Removing and installing the side bezel	Page 6
Removing and installing the front bezel.....	Page 7

Board Removal/Installation Procedures

Removing and installing RAM	Page 9
Removing and installing CPU card.....	Page 11
Removing and installing L2 cache	Page 13
Removing and installing PCI expansion cards.....	Page 14

Drive Removal/Installation Procedures

Removing and installing drives in the internal 3.5-inch drive bay	Page 16
Removing and installing drives in the front accessible 3.5-inch drive bay.....	Page 17
Removing and installing drives in the 5.25-inch drive bay.....	Page 20

System Level Removal/Installation Procedures

Removing and installing the MLB.....	Page 22
Removing and installing the power supply	Page 24

PowerTower Pro Specifications

CPU	PowerPC 604e at 180, 200, 225 or 250MHz
Main Logic Board	Tsunami (Comparable to a Macintosh 9500)
CPU Upgrade	Available via daughtercard replacement
MacOS	7.5.3, 7.5.5, 7.6, 7.6.1
Memory	8 DIMM slots—168-pin, 64 bit, 60 ns (1.24 Gb max); Memory interleaving supported
Cache	1 MB Level 2
SCSI	Internal: SCSI-2 Fast; 10 MB/sec data transfer rate External: SCSI-2; 5 MB/sec data transfer rate
Serial Ports	High speed GeoPort-compatible 9-pin modem and printer ports
Network	Built-in Ethernet AAUI port; Built-in Ethernet 10 Base-T port; LocalTalk serial connection via modem or printer port
Bus Expansion	Six PCI expansion slots
Floppy Drive	One 3.5-inch, 1.4MB floppy disk drive. Supports MacOS, Windows, DOS, OS/2 and ProDOS disk formats.
Video	No internal video. Ships standard with a high quality, accelerated video card with both Mac and SVGA connections
Audio	16 bit, 44.1 KHz Stereo in/out connections (microphone port requires line-level input, such as Apple's Plaintalk Microphone); Built-in speaker
ROM	Apple ROM soldered on logic board
Case style	ATX
Drive Bays	Four front accessible, full-height 5.25-inch drive bays; Two front accessible, full-height 3.5-inch drive bays; one internal, full-height 3.5-inch drive bay
Dimensions	7.7"(W) X 16.9"(H) X 17.3"(D); 27 lb (12.2 kg)
Power Supply	300W, 100V-240V (Domestic/International manual switching)



For Your Safety

To ensure your personal safety as well as prevent unnecessary damage to the computer, please follow all safety precautions when performing any service on Power Computing computers.

Note: Always make sure that the computer is powered down before attempting any service. To make sure that the computer is completely powered down, check the light behind the power button on the front bezel and make sure that it is off.

Preventing ESD (Electrostatic Discharge) - There are two means by which a technician can maintain a ground and eliminate ESD:

- wear an ESD wrist strap that is grounded to the computer
- power down the computer, but leave the CPU power cord plugged into the wall socket; touch the metal case of the power supply to ensure complete static discharge before service.

Do not wear loose clothing or jewelry that may become caught in the components inside of the computer case.

Make sure that the work environment is free from excessive moisture. Any moisture on the components of the computer may cause damage.

If you need further assistance, please call:

1-800-708-6227



CUDA Reset

The CUDA Reset button is a small red button located on the Main Logic Board. Depressing this button resets the CUDA Microcontroller Chip. This chip is responsible for the following functions:

- Turns system power on and off
- Manages system resets from various commands
- Maintains parameter RAM
- Manages the Apple Desktop Bus (ADB)
- Manages the real-time clock
- Lets an external signal from either Apple GeoPort serial port control system power

It is rarely necessary to reset CUDA, but many problems that appear to be hardware related can be fixed by doing so. Resetting CUDA will not harm the machine in any way. Some of the most common reasons to reset CUDA are:

- After adding RAM, the machine will not boot, RAM does not show up in the memory control panel, etc.
- Machine will not power up
- Machine powers up, but does not chime or boot
- A serial port remains inaccessible even after booting without extensions, resetting parameter RAM, etc.
- Machine will power down for no apparent reason
- After adding any hardware to the inside of the machine

Resetting CUDA

1. Shut down the computer and disconnect all external devices, but leave the power cable plugged in to ground the computer.
2. Remove the cover (refer to *Side Panel Removal/Installation* on page 6).
3. Touch the metal chassis of the machine. This will dissipate static electricity into ground.
4. Locate the CUDA Reset button (see *MLB Diagram* on page 5).
5. Press the CUDA Reset button for a few seconds.
6. Reboot, and verify resolution of the problem you wanted to solve.

Note: Resetting the CUDA will cause some system settings to default to factory settings.



MLB Diagram

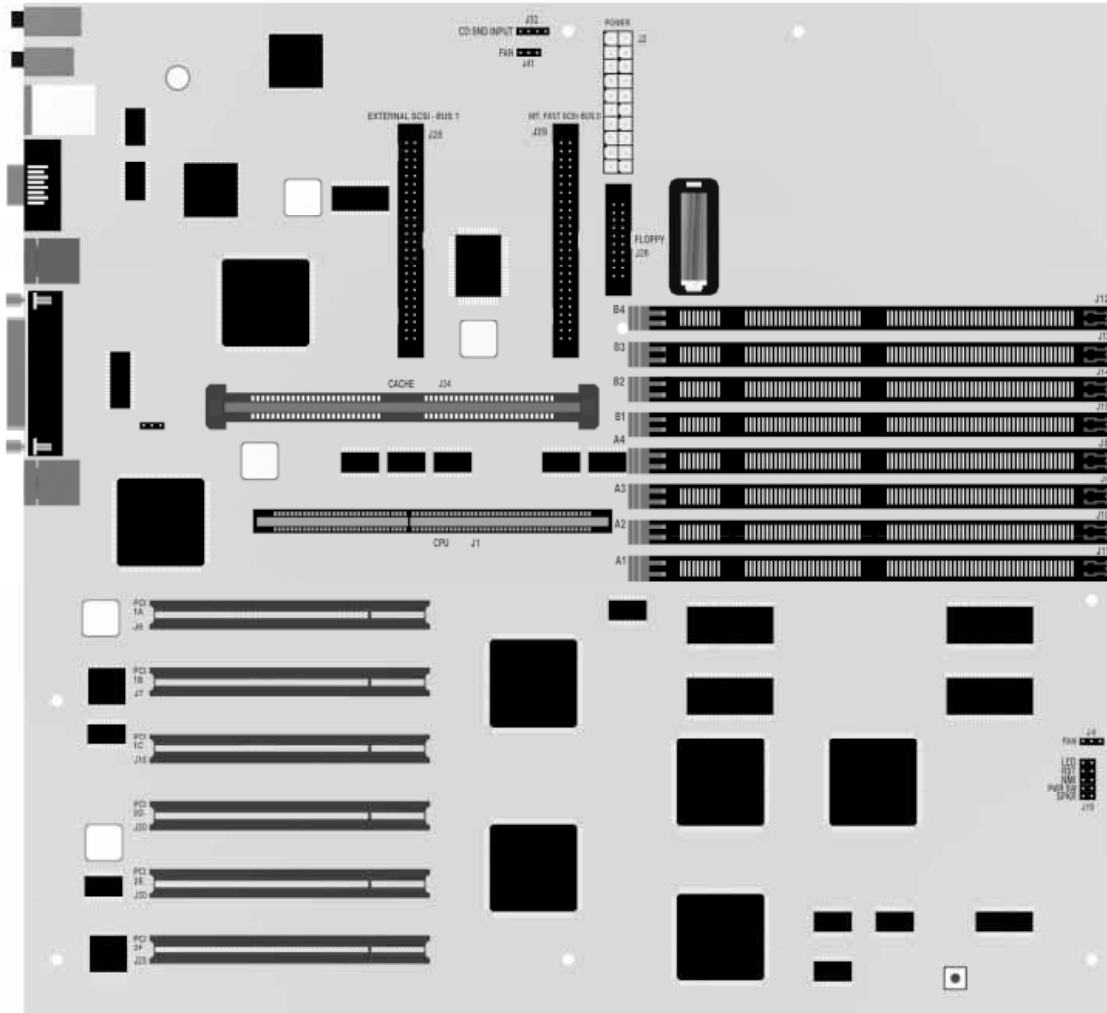



Side Panel Removal/Installation

Removing the Side Panel

1. Shut down the computer and turn off all external devices. If you do not have a grounding strap, leave the computer plugged into the wall socket. Leaving the computer plugged in ensures a positive ground.
2. Remove the two thumb screws on the back right hand side of the computer (rear of machine facing you). This may require the use of a flat head screw driver (see **Figure 1: Removing the side panel** on page 6).
3. Locate the depression located on the right side of the of the computer. Pull the side bezel toward the rear until it disengages. Only the side of the computer casing will be removed.

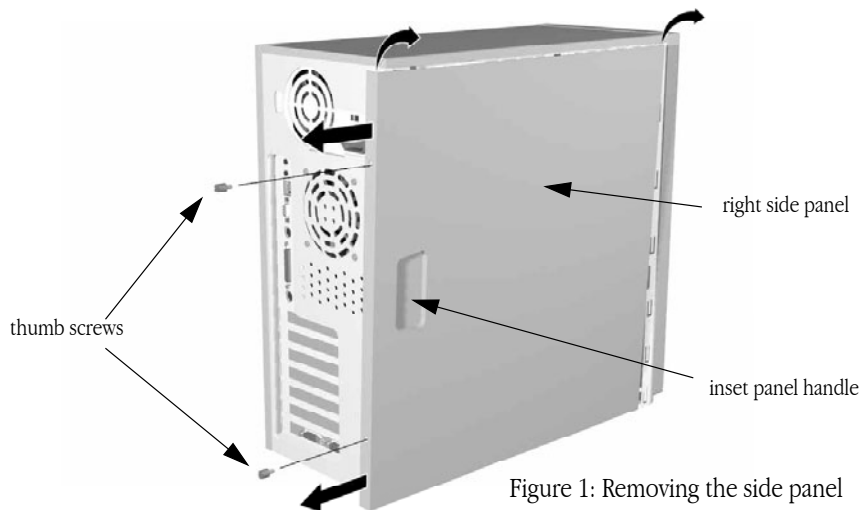

Figure 1: Removing the side panel

Installing the Side Panel

1. Place the side panel on the unit, making sure the brackets are lined up properly. These brackets are paired on the top and the bottom of the machine.
2. With brackets aligned properly, slide the side bezel toward the front of the machine. Be sure that the panel slides all the way into place. If the panel does not secure properly, tap the back plate firmly to reseat properly.
3. Once the panel is in its proper place, screw the thumb screws securely into the proper holes.



Front Bezel Removal/Installation

Removing the Front Bezel Cover

1. Remove the side panel (refer to *Side Panel Removal/Installation* on page 6).
2. Disengage the four tabs that secure the bezel to the left side of the computer (see *Figure 2: Disengage Bezel Tabs* on page 7). All four of these tabs must be disengaged before the front bezel can be removed. The tabs are located on the inside of the chassis frame:

- 2 inches from the top (flat)
- just below the center of the machine (round)
- 2 inches below the round middle tab (flat)
- one half inch from the bottom (flat)

Gently pull the bottom of the bezel away from the computer with your right hand while disengaging the tabs with your left hand. Start with the bottom tab and continually pull away from the computer. It may be necessary to use a pair of needlenose pliers to disengage the round tab.

3. Reach inside the computer and disengage the tab securing the right side of the bezel to the bottom of the chassis.
4. Pull the bezel forward, away from the computer.

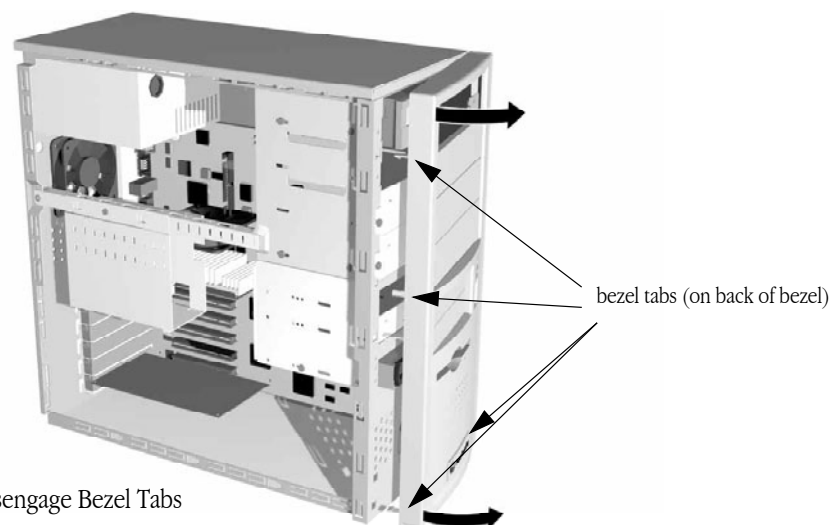

Figure 2: Disengage Bezel Tabs

Installing the Front Bezel

1. With the computer facing you (open side on the left), insert the tabs of the right side of the bezel into the slots on the chassis frame.
2. Push the left side of the bezel toward the computer until the tabs click into place.
3. Install the side panel (refer to *Side Panel Removal/Installation* on page 6).



RAM Removal/Installation

Note: The PowerTower Pro has eight DIMM slots near the front on the MLB. The DIMM slots are organized into two banks, A and B. Each bank has four slots, numbered A1 – A4 and B1 – B4. DIMMs can be inserted in any order, but if you install DIMMs of the same capacity in slots with the same number (A1 and B1, etc.), you will get better performance (interleaving) than if you install DIMMs unpaired. Slots with the same number provide interleaved memory. All DIMMs must be 168-pin, fast-paged mode, 60 nanosecond RAM access time or faster.

Removing RAM

1. Remove the front bezel (refer to **Front Bezel Removal/Installation** on page 7).
2. Remove the side panel (refer to **Side Panel Removal/Installation** on page 6).
3. Place the unit on its side with the MLB on the bottom and the open side facing up.
4. Remove the front accessible 3.5-inch drive bay (refer to **Removing 3.5-inch Drives in the Front Accessible Drive Bay** on page 17).
5. Locate the DIMM(s) you would like to remove. Loosen the desired DIMM module reaching in and pushing down on the small lever at the end of the DIMM slot. (see **Figure 4: Removing RAM** on page 9). The DIMM should pop loose from the slot at the lever end.

Figure 3:
DIMM slot
location

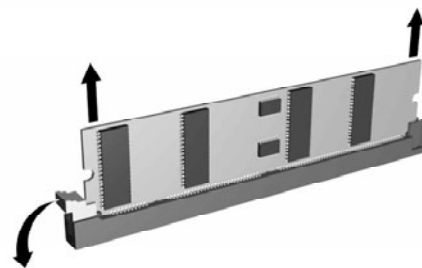
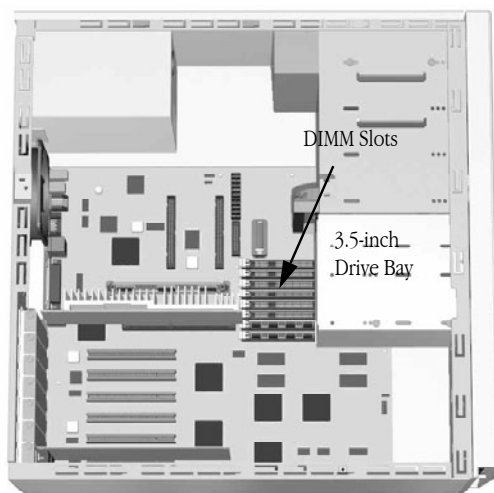

Figure 4: Removing RAM

6. Grasp the DIMM module on each end and evenly pull the module up and out of the slot.

Installing RAM

1. Hold the module (with the contacts down) with one hand at each end. Notice that there are two notches in the contact edge of the DIMM module.
2. Lower the DIMM squarely into the slot so that the notches in the DIMM line up with the notches in the slot. Slide the contacts straight into the slot and make sure the contacts are firmly seated in the slot. (see **Figure 5: Installing RAM** on page 10). When properly seated, the contacts on the bottom should not be visible.

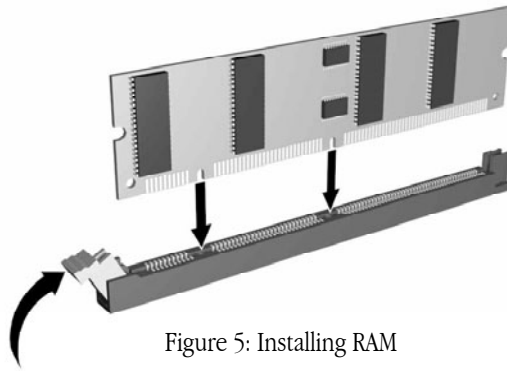

Figure 5: Installing RAM

Note: Don't force the DIMM module into the slot; if the MLB starts bending significantly, pull the DIMM out, reposition it, and try again. If the DIMM module is seated correctly, the lever at the end of the DIMM slot should be completely raised.

3. Raise the computer to the upright position. Replace the 3.5-inch drive bay (refer to **3.5-inch Drive Removal/Installation** on page 16).
5. Reset the CUDA (refer to **CUDA Reset** on page 4).
6. Install the side panel (refer to **Side Panel Removal/Installation** on page 6).



CPU Removal/Installation

Removing the CPU

1. Remove the side panel (refer to *Side Panel Removal/Installation* on page 6).
2. Place the unit on its side with the MLB on the bottom and the open side facing up.
3. Remove the screws that secure the internal 3.5-inch drive bay. One screw is in the cross bar and the other is on the top of the PCI expansion slot covers on the rear of the computer. Disconnect the cables to any devices in the bay. Slide the bay toward the front of the computer, then carefully lift the assembly straight up and out.

Note: The CPU fan is still attached to the bay. Follow the two wires from the fan to the MLB and disconnect them before fully removing the bay assembly. Set the assembly aside.

4. Place both hands on either side of the CPU card and lift up. Sometimes a gentle rocking motion from end to end (*not side to side*) will make it easier to remove the CPU card.

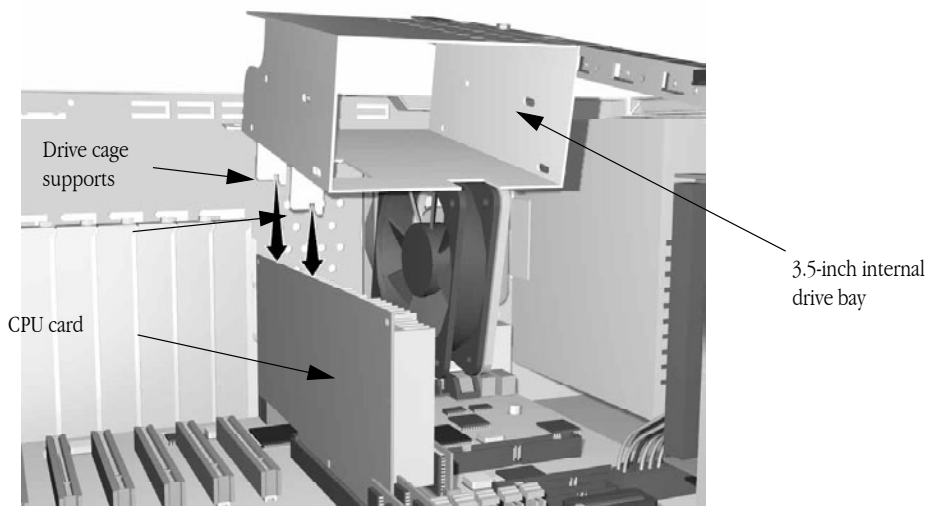

Installing the CPU

1. Hold the CPU card (contacts facing down) with one hand at each end. Notice that there is a notch in the contact edge of the CPU card.
2. Lower the CPU card squarely into the slot so that the notch in the CPU card lines up with the notch in the slot. Slide the contacts straight into the slot and make sure the contacts are firmly seated in the slot. (see **Figure 6: CPU removal** on page 11). When properly seated, the contacts on the bottom should not be visible.

Note: Don't force the CPU card into the slot; if the MLB starts bending significantly, pull the CPU card out, reposition it, and try again.

3. Replace the Internal 3.5-inch drive bay assembly (refer to **3.5-inch Drive Removal/Installation** on page 16).
4. Reset the CUDA (refer to **CUDA Reset** on page 4).
5. Replace the side panel (refer to **Side Panel Removal/Installation** on page 6).



Cache Removal/Installation

Removing the Cache

1. Remove the side panel. (refer to *Side Panel Removal/Installation* on page 6).
2. Place the unit on its side with the MLB on the bottom and the open side facing up.
3. Remove the internal 3.5-inch drive bay (refer to *3.5-inch Drive Removal/Installation* on page 16).
4. Place both hands on either side of the L2 cache card and lift up. Because the L2 cache is held in by a tight pressure fit, sometimes a gentle rocking motion from end to end (*not side to side*) will make it easier to remove the cache card.

Installing the Cache

1. Hold the L2 cache card (contacts facing down) with one hand at each end. Notice that there are notches in the contact edge of the L2 cache card.
2. Lower the L2 cache card squarely into the slot so that the notches in the L2 cache card line up with the notches in the slot. Slide the contacts straight into the slot and make sure the contacts are firmly seated in the slot. When properly seated, the contacts on the bottom should not be visible.

Note: Don't force the L2 cache card into the slot; if the MLB starts bending significantly, pull the L2 cache card out, reposition it, and try again.

3. Replace the internal 3.5-inch drive bay assembly (refer to *3.5-inch Drive Removal/Installation* on page 16).
4. Reset the CUDA (refer to *CUDA Reset* on page 4).
5. Replace the side panel (refer to *Side Panel Removal/Installation* on page 6).



PCI Cards Removal/Installation

Note: Before you install any expansion cards, be sure that the combined power consumption of the expansion cards does not exceed the limits of the computer. Refer to the documentation that came with the cards you are installing for their power consumption rating and to “Power requirements” in the *User's Guide* for the power consumption limit for this computer.

Removing PCI Cards

1. Remove the side panel (refer to *Side Panel Removal/Installation* on page 6).
2. Place the unit on its side with the MLB on the bottom and the open side facing up.
3. Disconnect any cables that may be attached to the PCI card.
4. Remove the screw attaching the PCI card to the top of the I/O slots.
5. Firmly grasp the PCI card and pull it straight out of the computer. Be careful not to damage any components that may be protruding through the I/O slot. Sometimes a gentle rocking motion from end to end (*not side to side*) will make it easier to remove the PCI card.

Installing PCI Cards

1. With the machine open side up, remove the retaining screw of the metal I/O slot cover from the slot you wish to use. (see *Figure 7: Removing PCI slot cover* on page 15).
2. Pull the I/O slot cover out the top so that the tongue at the bottom of the cover slides out of the slot in the chassis.

Figure 7: Removing PCI slot cover

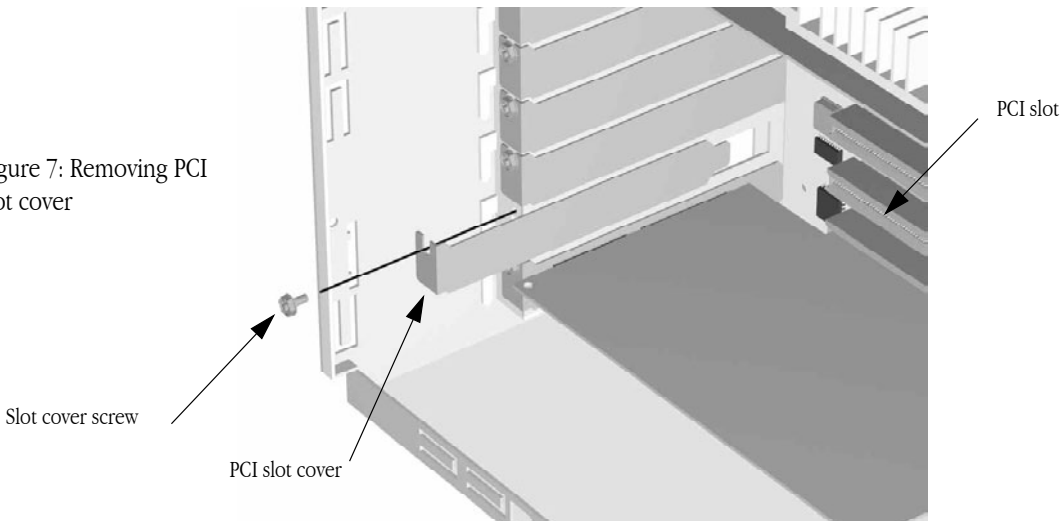

3. Hold the PCI card (contacts facing down) with one hand at each end. Notice that there is a notch in the contact edge of the PCI card.
4. Lower the PCI card squarely into the PCI slot so that the notch in the PCI card lines up with the notch in the PCI slot. Slide the contacts straight into the PCI slot and make sure the contacts are firmly seated in the slot. (see **Figure 8** on page 15). When properly seated, the contacts on the bottom should not be visible. Secure the PCI card to the chassis with the retaining screw.

Figure 8

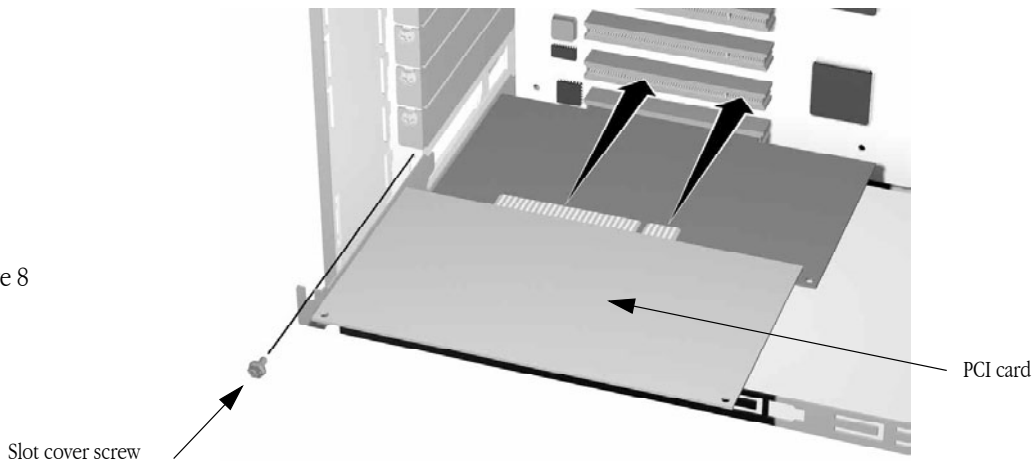

Note: Don't force the PCI card into the slot; if the MLB starts bending significantly, pull the PCI card out, reposition it, and try again.

5. Connect any wires or cables to the PCI card necessary for its proper operation.
6. Reset the CUDA (refer to **CUDA Reset** on page 4).
7. Replace the side panel (refer to **Side Panel Removal/Installation** on page 6).



3.5-inch Drive Removal/Installation

Removing 3.5-inch Drives from the Internal Drive Bay

1. Remove the side panel (refer to *Side Panel Removal/Installation* on page 6).
2. Place computer on its side with the MLB on the bottom and the open side facing up.
3. Disconnect the CPU cooling fan from the MLB (see *MLB Diagram* on page 5).
4. Disconnect all cables that are attached to any device(s) contained in the 3.5-inch drive bay. (see *Figure 9*: on page 16).

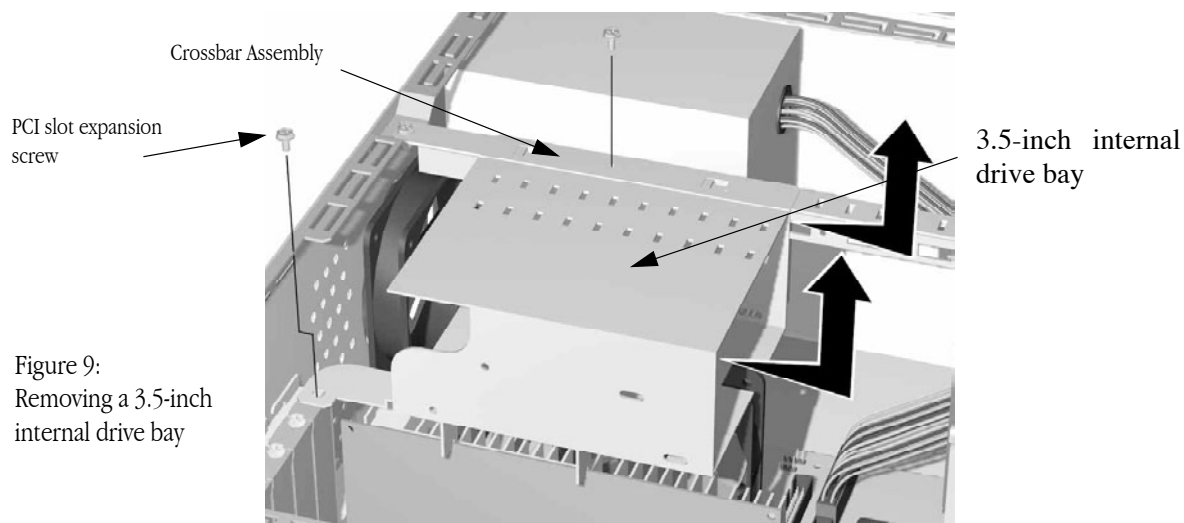

Figure 9:
Removing a 3.5-inch
internal drive bay

5. Remove the two screws that are holding the 3.5-inch drive bay in place.
 - the first screw is located in the center of the crossbar
 - the second screw is located directly above the last PCI slot cover

CAUTION! Be very careful! The CPU cooling fan is mounted on this bay with the fan power lead attached to the MLB.

6. Gently slide the drive bay toward the front of the machine, disengaging the tabs holding the bay down. Lift the assembly up and out of the machine.
7. Remove four screws located in pairs on the either side of the drive. Slide the drive out of the bay.

Installing 3.5-inch Drives in the Internal Bay

1. Slide the drive into the bay and align the holes in the drive with the holes in the bay. There is room to mount two half-height drives and appropriate holes for each in the side of the bay. Insert two screws on each side of the bay to secure the drive to the bay.
2. Set the drive bay on the slide brackets on the crossbar and move toward the back of the computer until the bay has locked into position

Note: Be very careful of the CPU cooling fan mounted on this bay.

3. Replace the screws securing the drive bay to the chassis.
 - The first screw is located in the center of the crossbar
 - The second screw is located directly above last PCI slot cover
4. Connect the CPU cooling fan to the MLB. (see **MLB Diagram** on page 5).
5. Connect all cables for the drives located within the drive bay.
6. Reset the CUDA (refer to **CUDA Reset** on page 4).
7. Install the side panel (refer to **Side Panel Removal/Installation** on page 6).

Removing 3.5-inch Drives in the Front Accessible Drive Bay

1. Remove the side panel (refer to **Side Panel Removal/Installation** on page 6).
2. Remove the front bezel (refer to **Front Bezel Removal/Installation** on page 7).
3. Place the computer on its side with the MLB on the bottom and the open side facing up.
4. Unscrew the two screws on the front of the computer located on either side of the floppy disk drive faceplate. Pull the entire 3.5-inch drive bay toward the rear of the computer until it disengages. Disconnect the components located in the 3.5-inch drive bay and lay them aside. (see **Figure 10: Front bay installation** on page 18).

5. Once removed from the slides, angle the bay out of the machine.
6. Remove the four screws, located in pairs, on the either side of the drive.
7. Slide the drive out of the bay.

Figure 10: Front bay installation

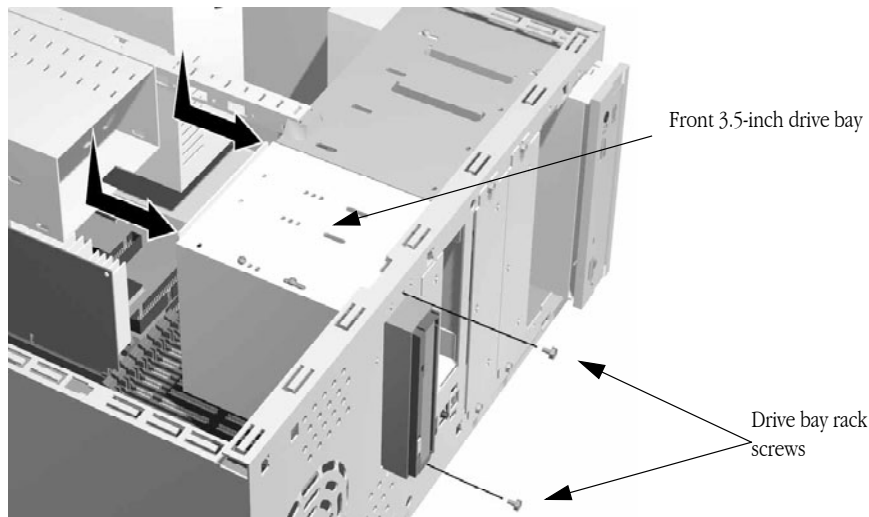

Installing 3.5-inch Drives in the Front Accessible Drive Bay

1. Slide the drive into the bay and align the holes in the drive with the holes in the bay. There is room to mount two half-height drives and appropriate holes for each in the side of the bay.
2. Insert two screws on each side of the bay to secure the drive to the bay. The floppy disk drive should protrude about 1.5-inches past the front of the chassis in order to be flush against the front bezel when it is installed.
3. Slide the bay in at a 45° angle making sure that the floppy disk drive is properly aligned with the opening on the front of the chassis. Once the floppy disk drive is aligned, push the bay toward the top of the 5.25-inch drive bay.

With the 3.5-inch bay resting against the 5.25-inch bay, push the 3.5-inch bay toward the front of the computer until it has fully engaged the slide brackets. There are two slides located on either side of the 5.25-inch bay. All of these should be firmly seated when the 3.5-inch bay is installed properly. (see

Figure 11: CDRom Removal on page 20).

4. Secure the bay with the screws on either side of the floppy disk drive.
5. Connect all cables for the drives located within the drive bay.
6. Reset the CUDA (refer to **CUDA Reset** on page 4).
7. Install the front bezel (refer to **Front Bezel Removal/Installation** on page 7).
8. Install the side panel (refer to **Side Panel Removal/Installation** on page 6).



5.25-inch Drive Removal/Installation

Removing 5.25-inch Drives

1. Remove the side panel (refer to *Side Panel Removal/Installation* on page 6).
2. Remove the front bezel. (refer to *Front Bezel Removal/Installation* on page 7).
3. Disconnect all cables that are attached to the device(s) being removed. (see *Figure 11: CDROM Removal* on page 20).

Figure 11: CDROM Removal

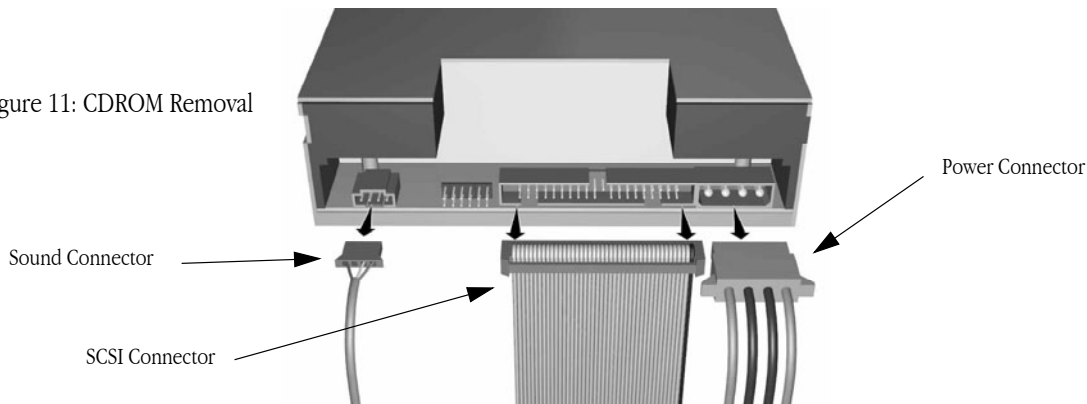

4. Remove the drive's retaining screws located on the left side of the 5.25-inch drive bay.
5. Determine how the right side of the drive is secured to the chassis: a metal bracket or a plastic slide rail.
6. If the drive is secured with a metal bracket:
 - Remove the screw located on the front of the computer chassis immediately to the right of the drive's faceplate.
 - Slide the drive directly out of the front of the chassis.
 - Remove the slide mounting bracket from the side of the drive by removing the two mounting screws.
7. If the drive is secured with a plastic side rail:
 - Press the locking tab at the front of the rail toward the drive.
 - Slide the drive directly out of the front of the chassis.

- Remove the side rail from the side of the drive by removing the two mounting screws. (see **Figure 12: Drive rail removal** on page 21).

Figure 12: Drive rail removal

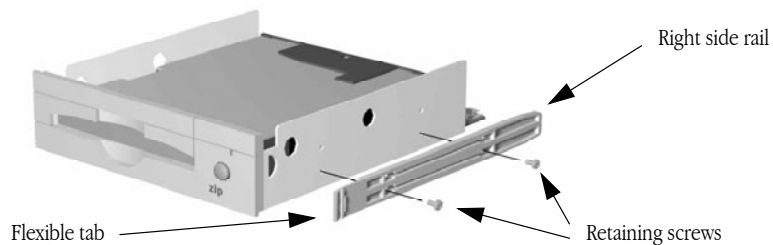

Installing 5.25-inch Drives

1. Attach the slide mounting bracket to the right hand side of the drive (drive faceplate facing you). If a plastic slide rail is used, make sure the flexible tab faces the front of the drive and flexes toward the drive.
2. Slide the drive into the appropriate bay location making sure the cable connections are facing the rear of the computer. Slide the drive in until the left slide is flush with the front of the computer or the plastic tab locks in place.
3. If a metal bracket is used, secure the screw located on the front of the computer chassis immediately to the right of the drive's faceplate.
4. Secure the drive's retaining screws located on the left side of the 5.25-inch drive bay.
5. Connect all cables for the drives located within the drive bay.
6. Reset the CUDA (refer to **CUDA Reset** on page 4).
7. Install the front bezel (refer to **Front Bezel Removal/Installation** on page 7).
8. Install the side panel (refer to **Side Panel Removal/Installation** on page 6).



Removal/Installation of MLB

Removing the MLB (Main Logic Board)

1. Remove the side panel (refer to *Side Panel Removal/Installation* on page 6).
2. Place the computer on its side with the MLB on the bottom and the open side facing up.
3. Remove the base from the chassis. The base is retained with two screws on the back in the bottom center of the computer and one directly on the bottom of the computer. Slide the base toward the rear of the computer to remove.
4. Remove the internal 3.5-inch drive bay (refer to *Removing 3.5-inch Drives from the Internal Drive Bay* on page 16).
5. Remove the processor card (refer to *Removing the CPU* on page 11).
6. Remove the cache card (refer to *Removing the Cache* on page 13).
7. Remove the PCI card(s) (refer to *Removing PCI Cards* on page 14).
8. Disconnect the cables attached to the MLB. Disconnect the power cable by pressing the retaining clip facing the front of the computer, then pulling straight up. Disconnect all other cables by pulling them straight up from their sockets.
9. Remove the eight securing screws that affix the logic board to the chassis (refer to *Figure 13: Removing the main logic board* on page 22).
10. Lift the MLB slightly and pull it out of the chassis through the bottom.
11. Remove the RAM from the MLB.

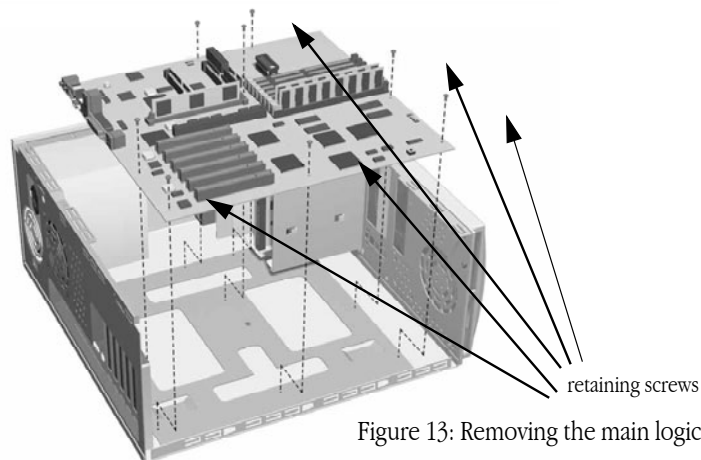

Figure 13: Removing the main logic board

Installing the MLB

1. Install the RAM on the MLB.
2. Insert the MLB in the chassis through the bottom. Be careful to align the ports on the board to the openings in the back of the computer. Also be careful not to trap any of the wiring below the chassis and the MLB.
3. Replace the eight securing screws affixing the MLB to the chassis.
4. Replace the base of the chassis and install the two securing screws.
5. Reconnect the cables attached to the MLB. Connect the power cable by pressing the retaining clip facing the front of the computer, then pressing down. Connect all remaining cables to their connectors.

Note: If the cable does not have a directional connector, then connect it with the label on the cable connector facing the rear of the computer.

6. Install the PCI card(s) (refer to *Installing PCI Cards* on page 14).
7. Install the Cache card (refer to *Installing the Cache* on page 13).
8. Install the CPU (refer to *Installing the CPU* on page 12).
9. Install the internal 3.5-inch drive bay (refer to *Installing 3.5-inch Drives in the Front Accessible Drive Bay* on page 18).
10. Reset the CUDA (refer to *CUDA Reset* on page 4).
11. Install the side panel (refer to *Side Panel Removal/Installation* on page 6).



Removal/Installation of Power Supply

Removing the Power Supply

1. Remove the side panel. (refer to *Side Panel Removal/Installation* on page 6).
2. Place the computer on its side with the MLB on the bottom and the open side facing up.
3. Disconnect the logic board power connector from the MLB. The connectors will have red, white, blue, and black wires coming out of them that lead back to the power supply. Disconnect the power cable by pressing in on the retaining clip and pulling straight up.
4. Remove the power connectors from all internal SCSI devices. These connectors are approximately one inch long with translucent white plugs with black, blue, yellow, red, and orange wires which lead back to the power supply.
5. Remove the four chassis retaining screws that hold the power supply in place. These screws are located on the outside rear of the computer, surrounding the power supply cooling fan (refer to *Figure 14: Power Supply Removal* on page 25).
 - the first screw is located above and to the left of the power supply fan.
 - the second screw is located below and to the left of the power supply fan.
 - the third screw is located below and to the right of the power supply fan.
 - the fourth screw is located above and to the right.

CAUTION: Do not remove any screws unless you are sure that they are chassis retaining screws. There are retaining screws that hold the power supply components together as well. These screws must not be removed.

6. Pull the power supply directly up and out of the chassis.

Figure 14: Power Supply Removal

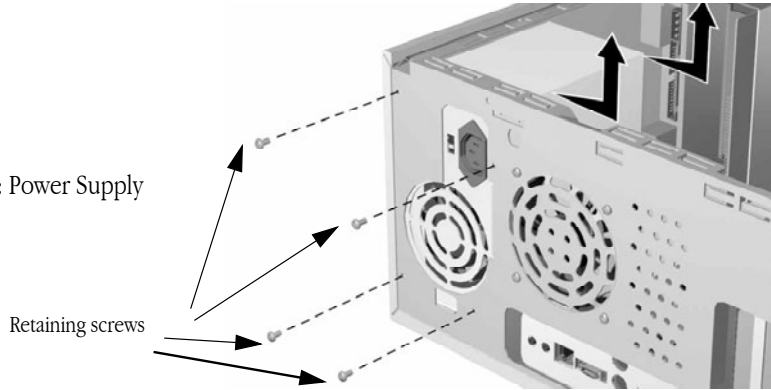

Installing the Power Supply

1. Slide the power supply into place making sure that it is seated properly.
2. Secure the power supply with the four retaining screws on the back of the chassis.
 - the first screw is located above and to the left of the power supply fan
 - the second screw is located below and to the left of the power supply fan
 - the third screw is located below and to the right of the power supply fan
 - the fourth screw is located above and to the right
3. Connect the power connectors to all internal SCSI devices.
4. Connect the logic board power connector to the MLB.
5. Reset the CUDA (refer to **CUDA Reset** on page 4).
6. Install the side panel (refer to **Side Panel Removal/Installation** on page 6).

This module was written and designed by:
Michael Scott Clay.

Additional contributions by:
Shane Nestle
Jeff Pryor

Edited by
Mark Wood
Laurie Veatch

This Power Computing module was written, edited and produced on a desktop publishing system using Power Computing system that use the Mac OS.

Every effort has been made to ensure that the information in the module is accurate. Power Computing is not responsible for printing or clerical errors.

Mention of third-party products is for informational purposes only and constitutes neither an endorsement nor a recommendation. Power Computing no responsibility with regard to the performance or use of these products.



© 1997 Power Computing Corporation

Power Computing Corporation
2400 S. IH-35
Round Rock, Texas 78681-7903